



TIKKOS RACING

UNIVERSAL ALUMINIZED MUFFLERS CATALOGUE

Universal Aluminized Mufflers
Resonator Mufflers (Handmade)

www.tikkosracing.com

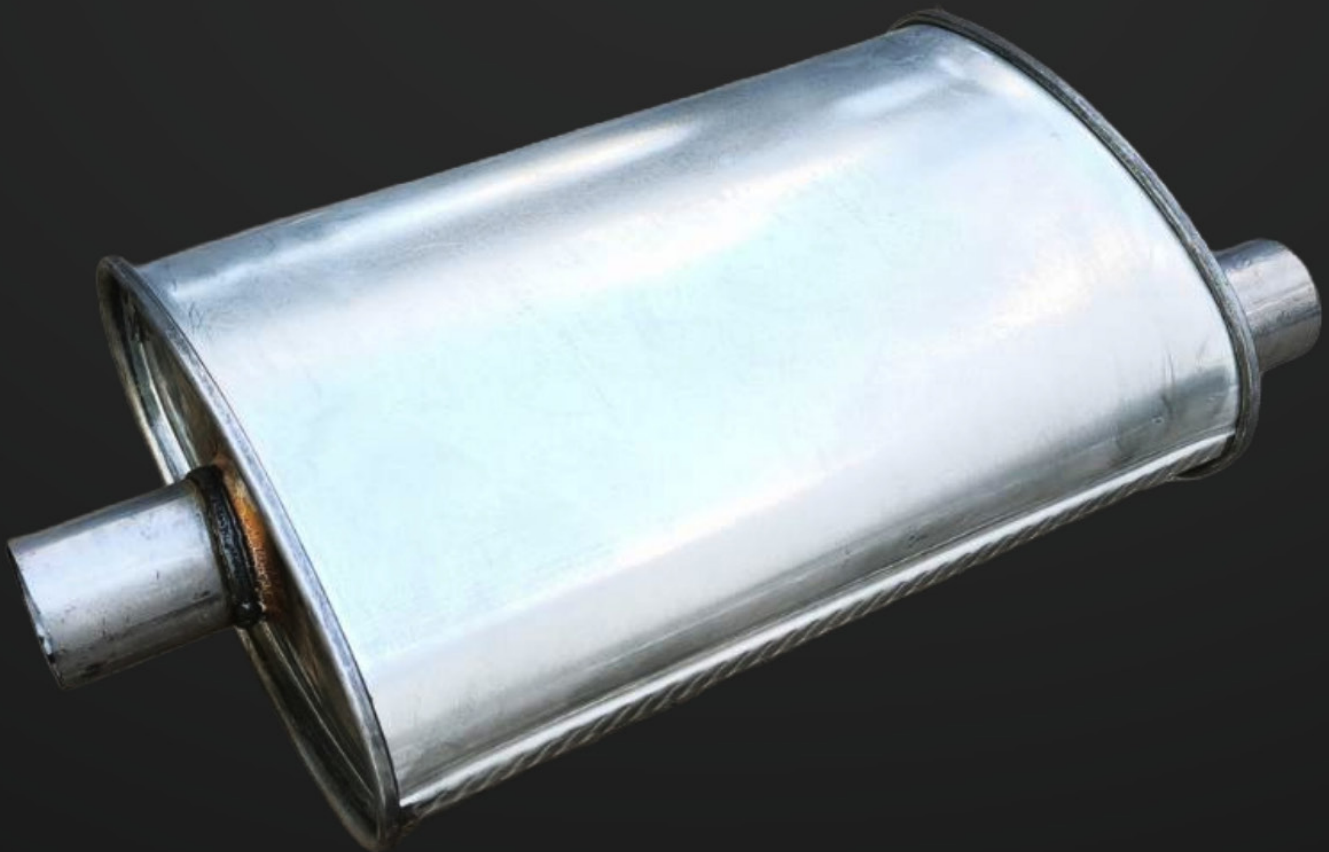

UNIVERSAL ALUMINIZED MUFFLERS

00.01

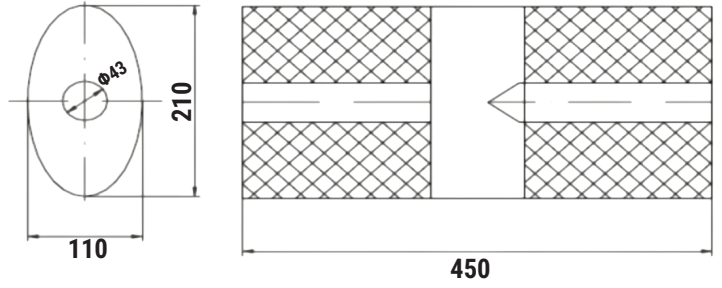

00.03

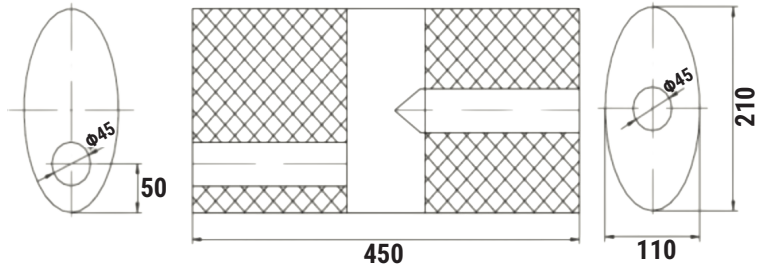

00.08

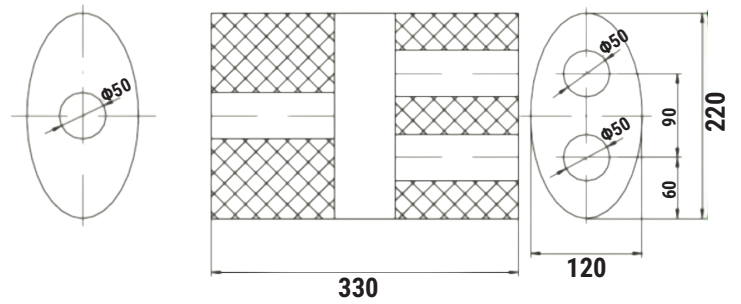

00.11

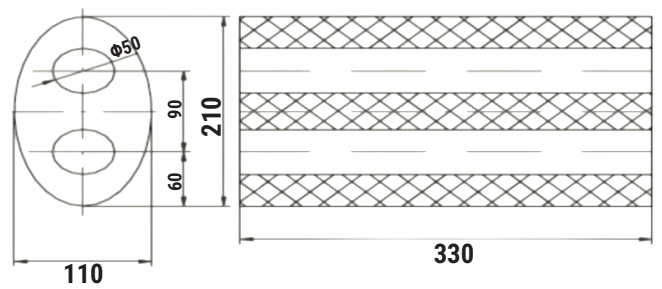

00.13

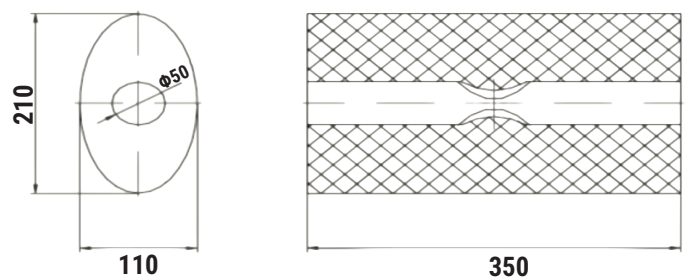

UNIVERSAL ALUMINIZED MUFFLERS

00.14

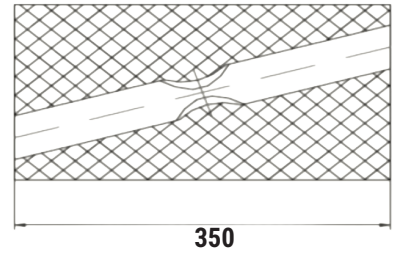
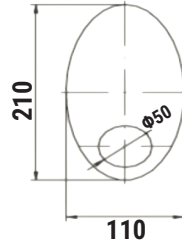

00.16

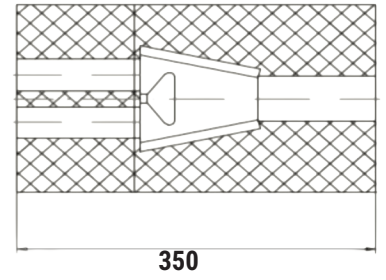
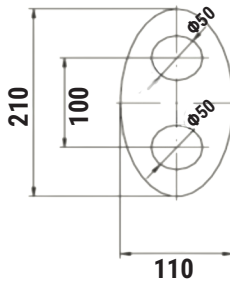

00.17

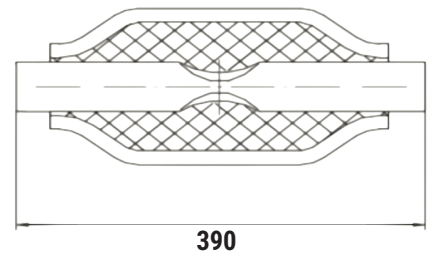
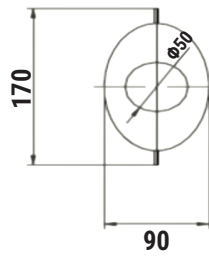

00.20

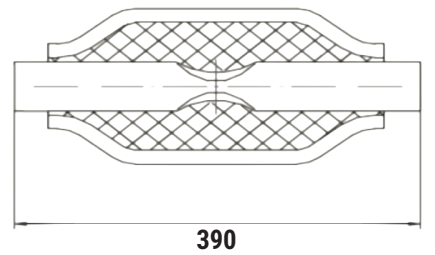
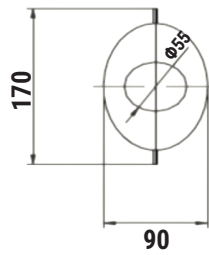

00.22

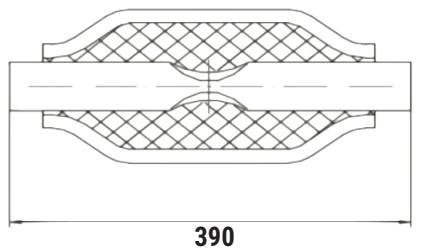
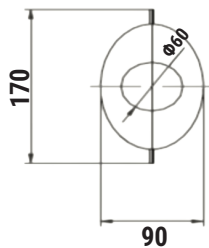

UNIVERSAL ALUMINIZED MUFFLERS

00.26

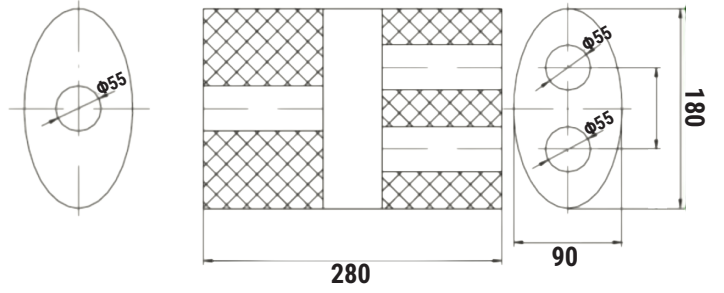

00.27

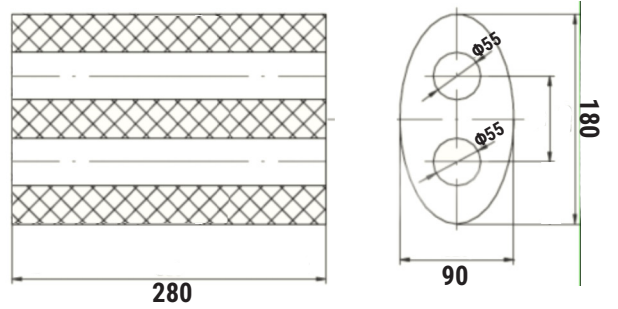

21.236

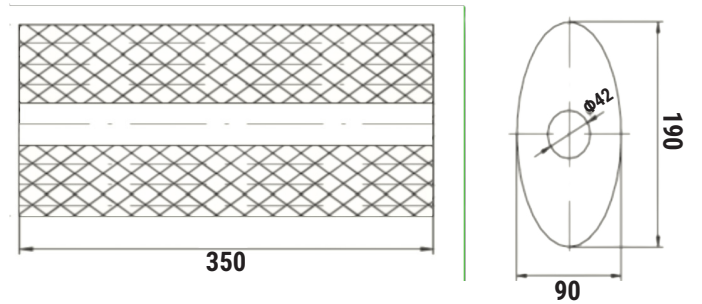

36.03

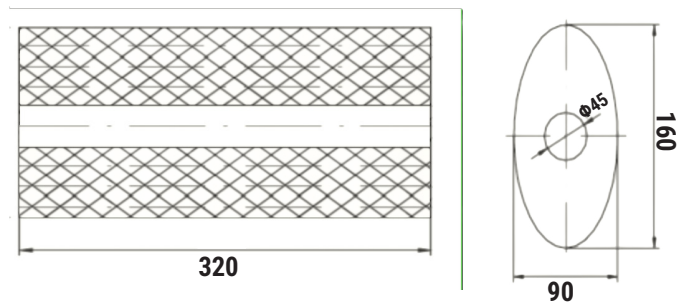

36.04

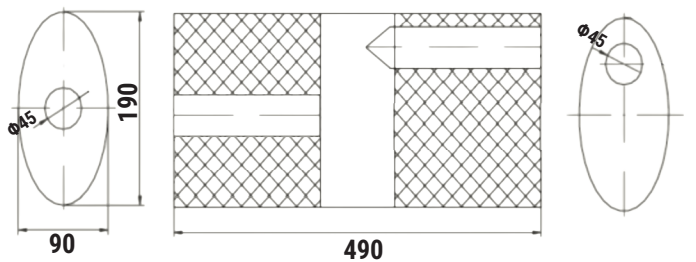

UNIVERSAL ALUMINIZED MUFFLERS

37.02

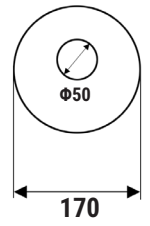
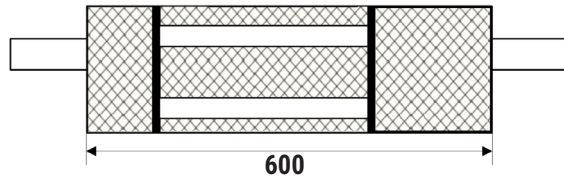

37.05

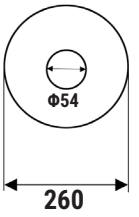
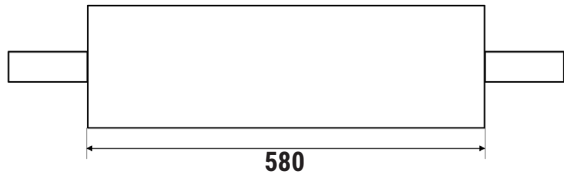

45.03

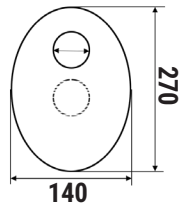
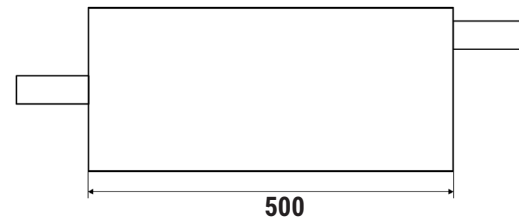

60.00

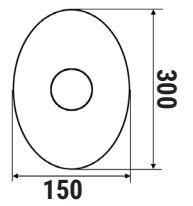
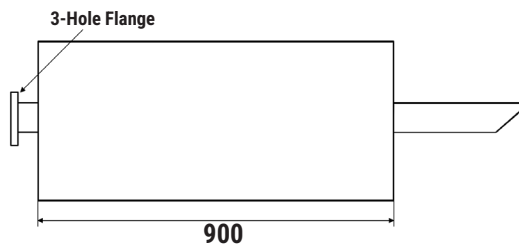

UNIVERSAL ALUMINIZED MUFFLERS

100.6007

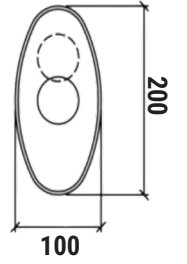
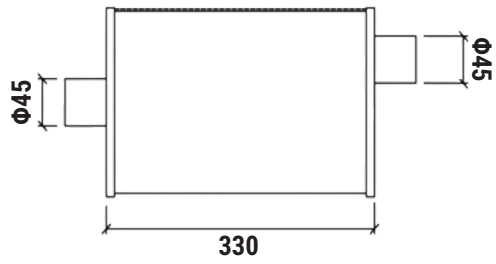

100.6008

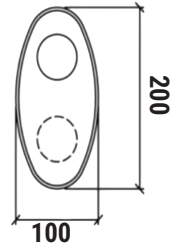
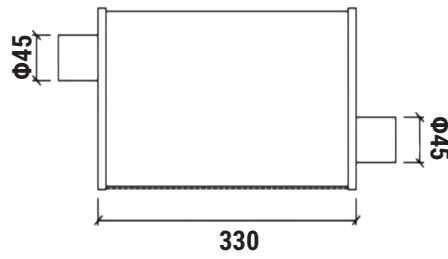

100.6009

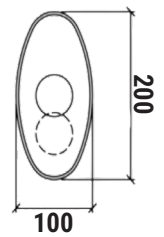
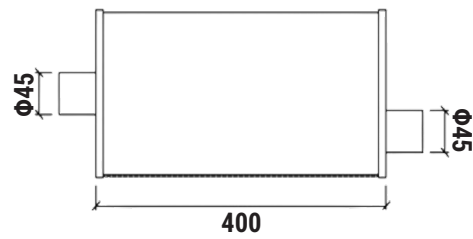

100.6013

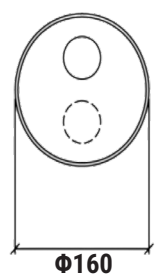
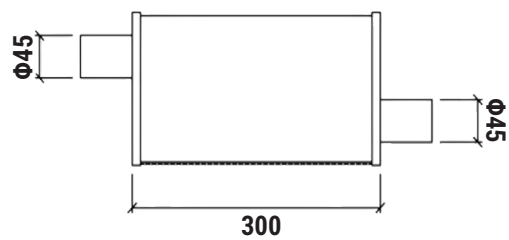

100.6017

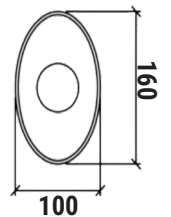
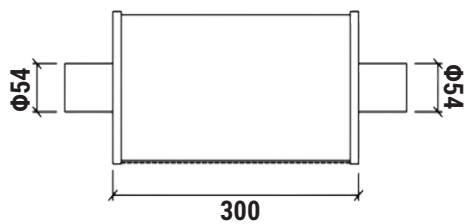

UNIVERSAL ALUMINIZED MUFFLERS

100.6026

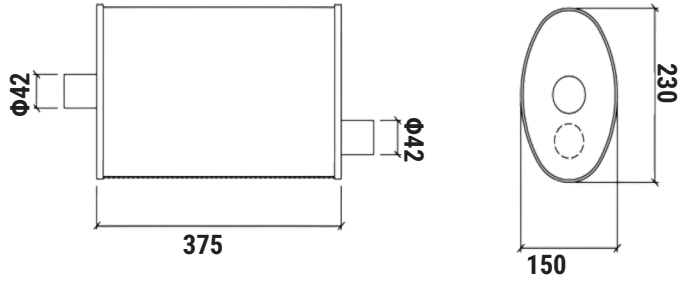

100.6029

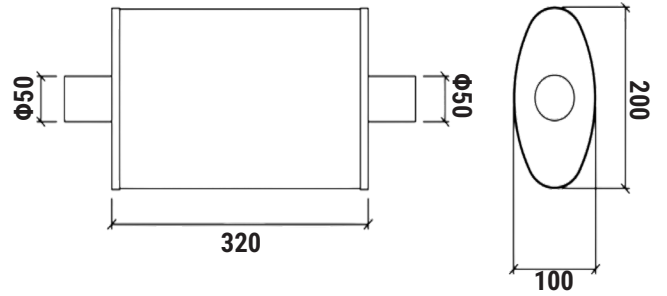
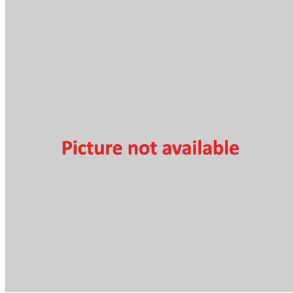

100.6031

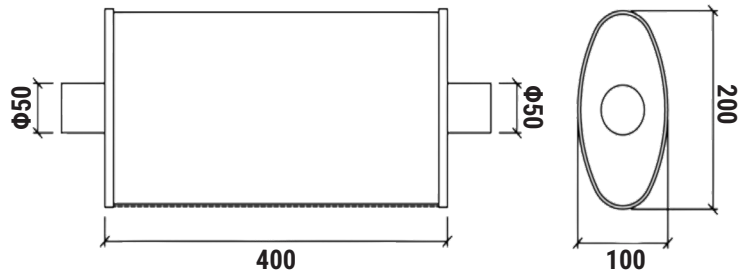

100.6034

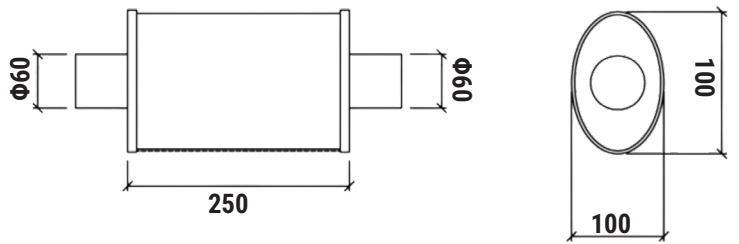

100.6035

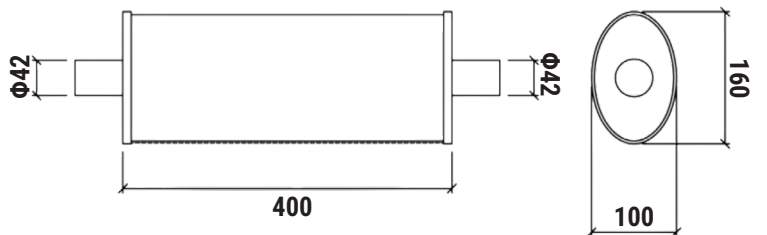

UNIVERSAL ALUMINIZED MUFFLERS

100.6036

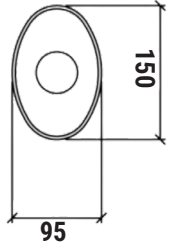
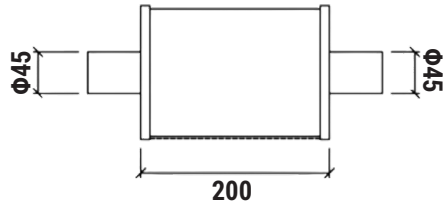
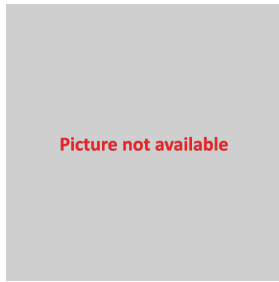

100.6040

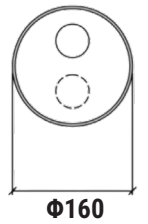
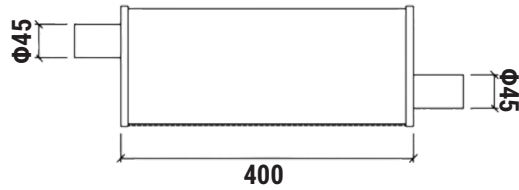
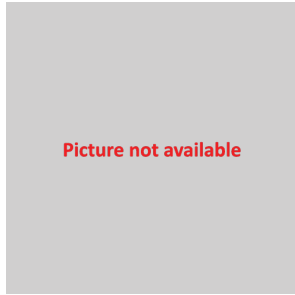

100.6046

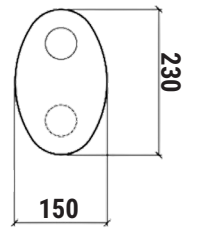
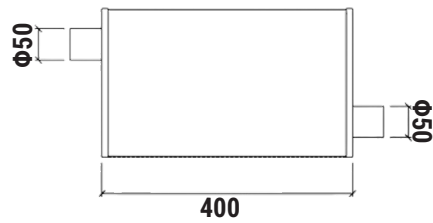
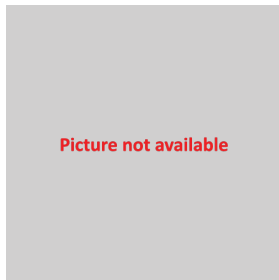

100.6047

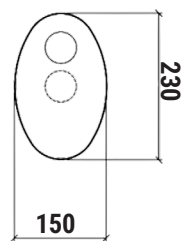
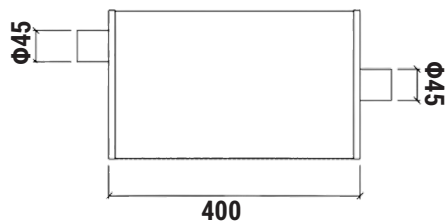

100.6048

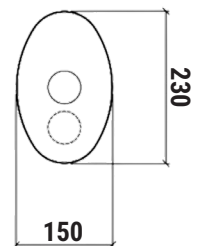
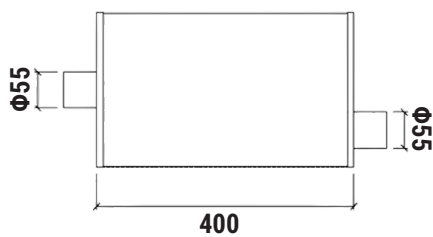

UNIVERSAL ALUMINIZED MUFFLERS

100.6064

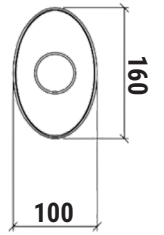
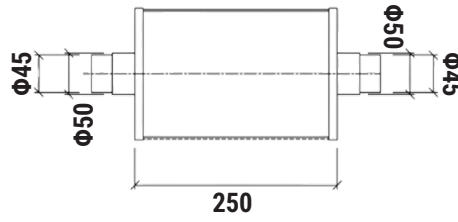

100411

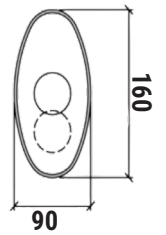
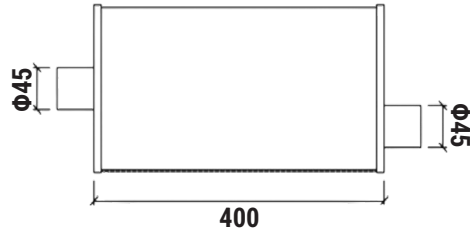
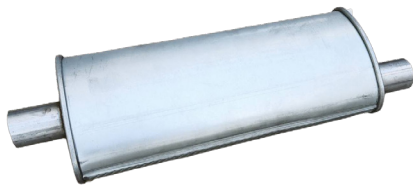

100412

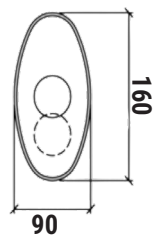
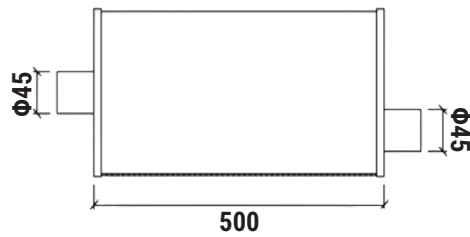
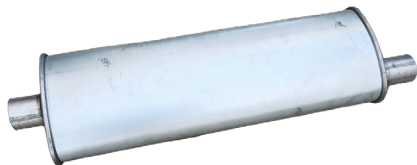

100435

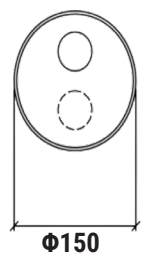
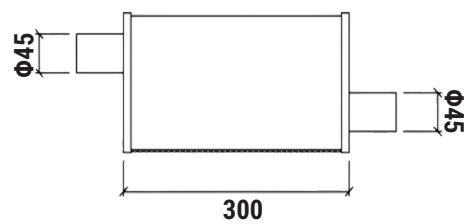

100437

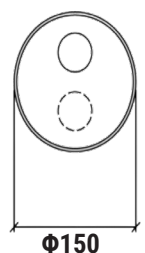
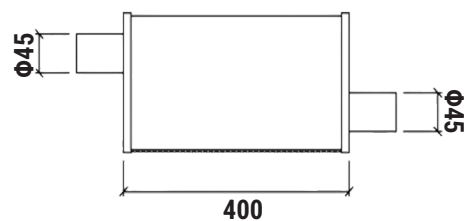

UNIVERSAL ALUMINIZED MUFFLERS

100438

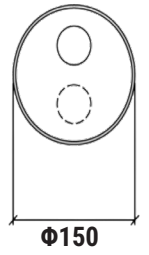
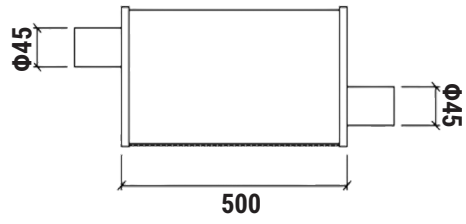

100448

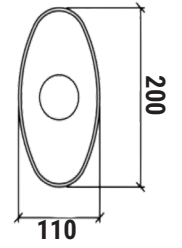
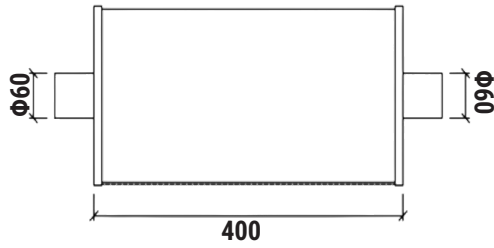

100449

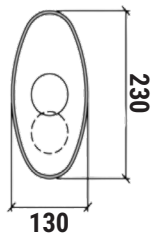
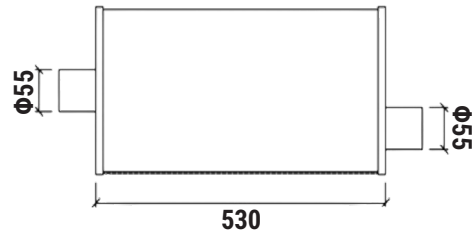

100476

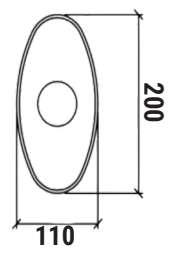
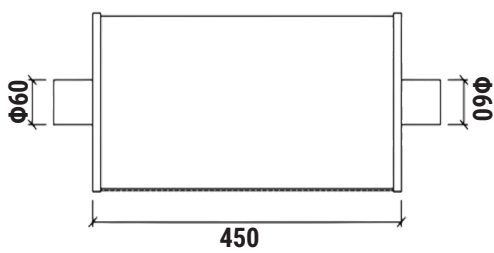

100488

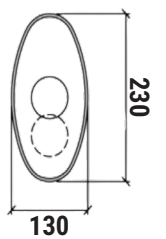
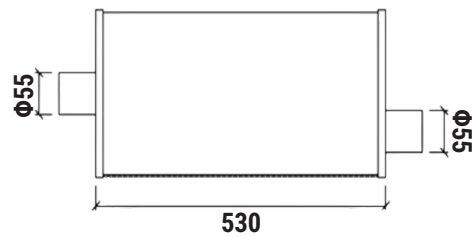

UNIVERSAL ALUMINIZED MUFFLERS

100501

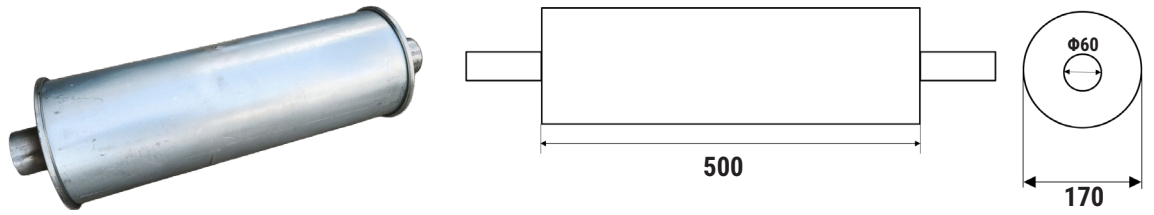

100502

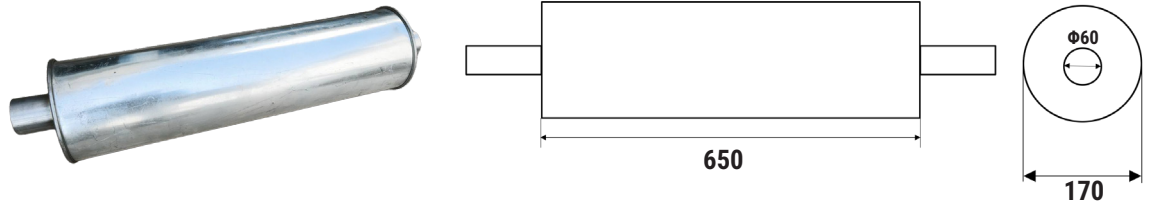

100503

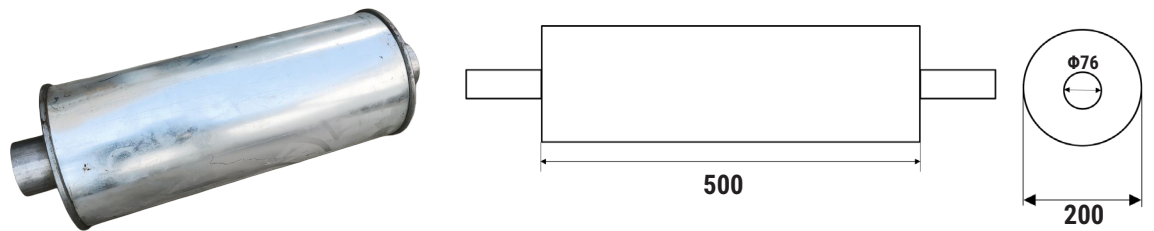

100504

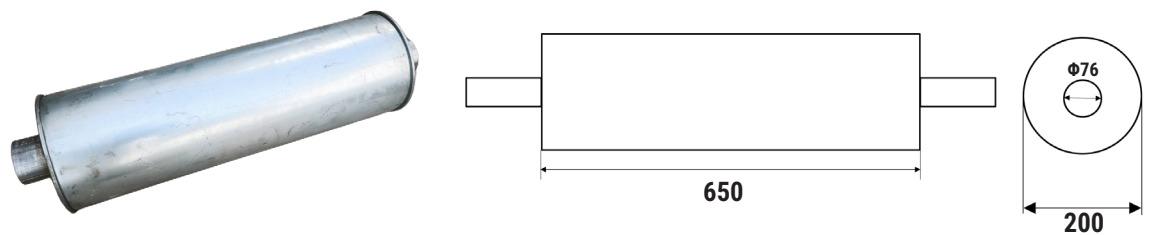

100505

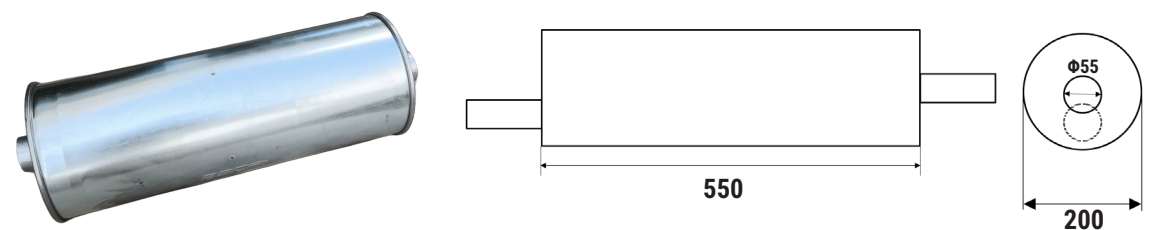

UNIVERSAL ALUMINIZED MUFFLERS

100506

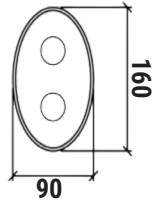
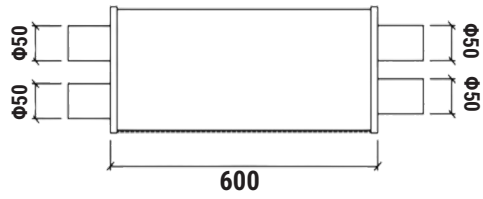

100513

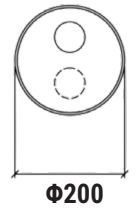
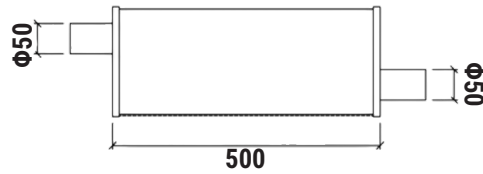

100560

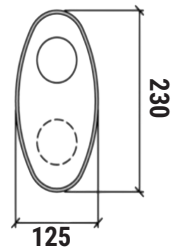
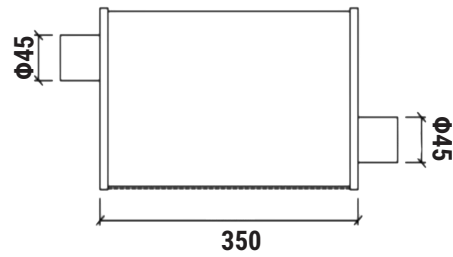

100561

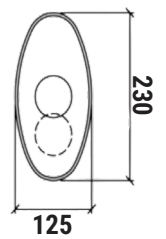
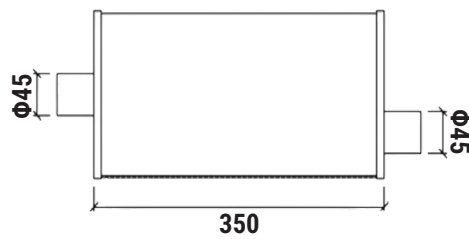

100563

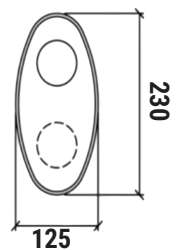
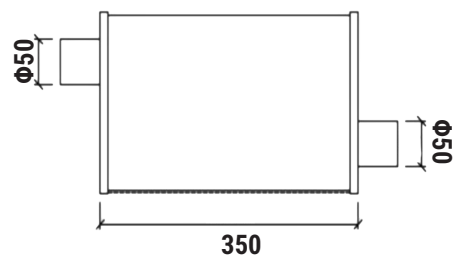

UNIVERSAL ALUMINIZED MUFFLERS

100564

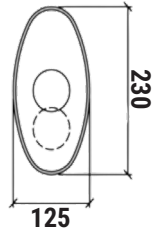
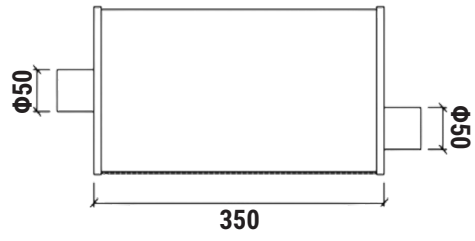

100566

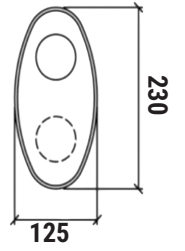
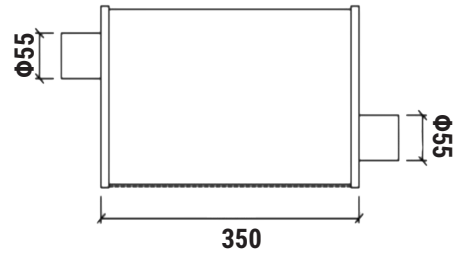

100567

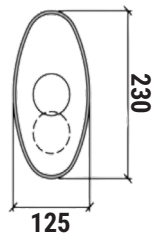
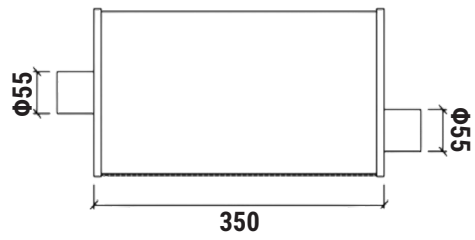

100569

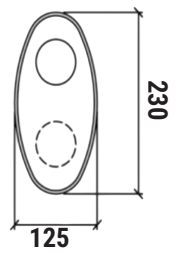
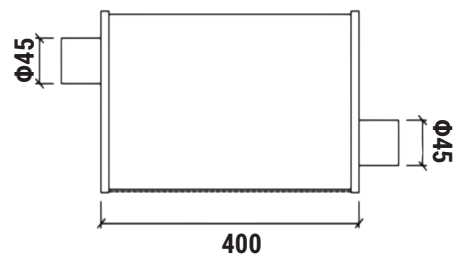

100570

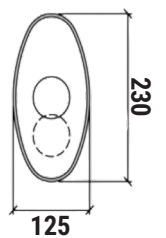
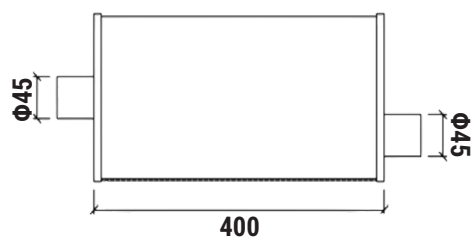

UNIVERSAL ALUMINIZED MUFFLERS

100572

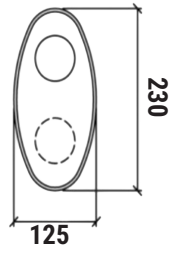
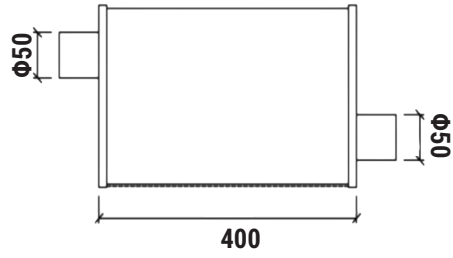

100573

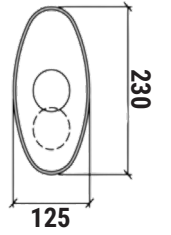
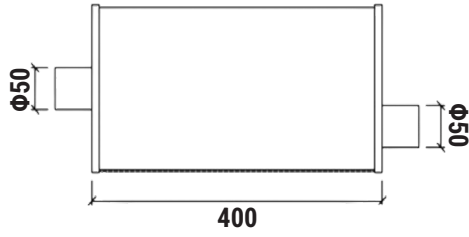

100581

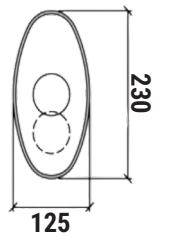
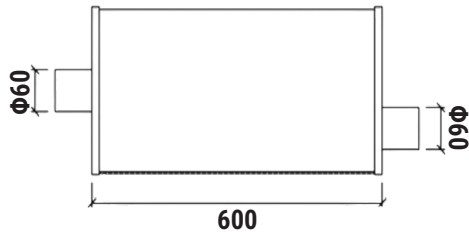

100583

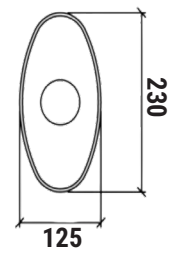
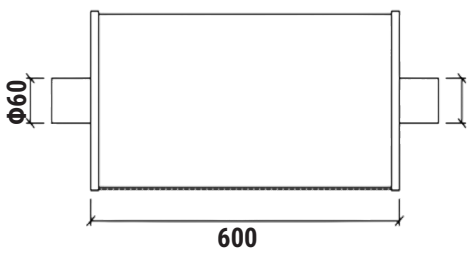

100584

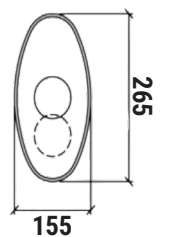
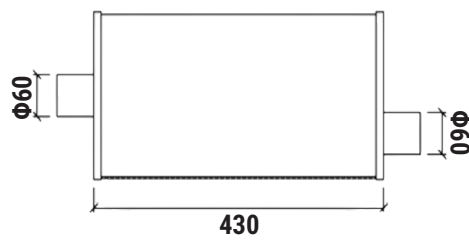

UNIVERSAL ALUMINIZED MUFFLERS

100587

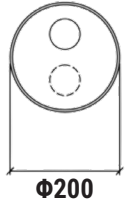
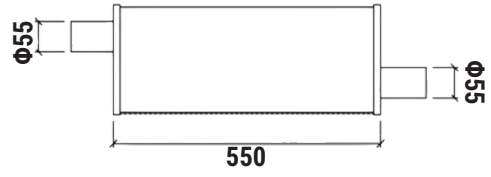

ALUMINIZED RESONATOR MUFFLERS

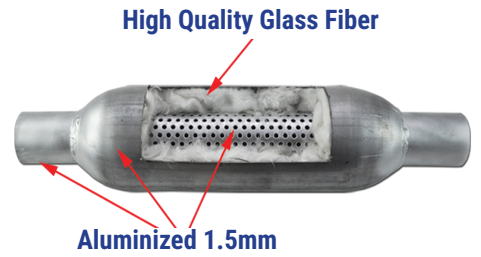
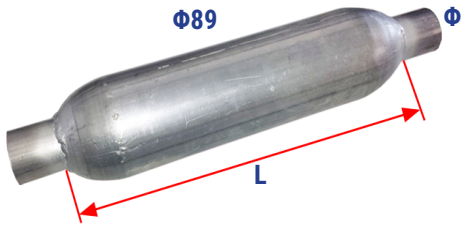

- RM20** Φ89 L200 Φ38
- RM21** Φ89 L250 Φ38
- RM22** Φ89 L300 Φ38
- RM23** Φ89 L350 Φ38
- RM24** Φ89 L400 Φ38
- RM25** Φ89 L450 Φ38
- RM26** Φ89 L500 Φ38

- RM30** Φ89 L200 Φ42
- RM31** Φ89 L250 Φ42
- RM32** Φ89 L300 Φ42
- RM33** Φ89 L350 Φ42
- RM34** Φ89 L400 Φ42
- RM35** Φ89 L450 Φ42
- RM36** Φ89 L500 Φ42

- RM40** Φ89 L200 Φ45
- RM41** Φ89 L250 Φ45
- RM42** Φ89 L300 Φ45
- RM43** Φ89 L350 Φ45
- RM44** Φ89 L400 Φ45
- RM45** Φ89 L450 Φ45
- RM46** Φ89 L500 Φ45

- RM50** Φ89 L200 Φ48
- RM51** Φ89 L250 Φ48
- RM52** Φ89 L300 Φ48
- RM53** Φ89 L350 Φ48
- RM54** Φ89 L400 Φ48
- RM55** Φ89 L450 Φ48
- RM56** Φ89 L500 Φ48

- RM60** Φ89 L200 Φ50
- RM61** Φ89 L250 Φ50
- RM62** Φ89 L300 Φ50
- RM63** Φ89 L350 Φ50
- RM64** Φ89 L400 Φ50
- RM65** Φ89 L450 Φ50
- RM66** Φ89 L500 Φ50

- RM70** Φ89 L200 Φ55
- RM71** Φ89 L250 Φ55
- RM72** Φ89 L300 Φ55
- RM73** Φ89 L350 Φ55
- RM74** Φ89 L400 Φ55
- RM75** Φ89 L450 Φ55
- RM76** Φ89 L500 Φ55

- RM80** Φ89 L200 Φ60
- RM81** Φ89 L250 Φ60
- RM82** Φ89 L300 Φ60
- RM83** Φ89 L350 Φ60
- RM84** Φ89 L400 Φ60
- RM85** Φ89 L450 Φ60
- RM86** Φ89 L500 Φ60

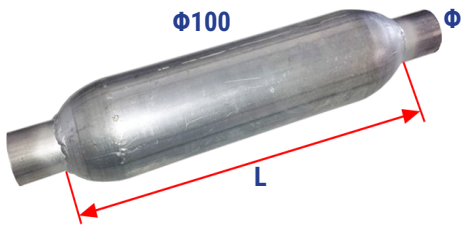

- RM100** Φ100 L200 Φ50
- RM101** Φ100 L250 Φ50
- RM102** Φ100 L300 Φ50
- RM103** Φ100 L350 Φ50
- RM104** Φ100 L400 Φ50
- RM105** Φ100 L450 Φ50
- RM106** Φ100 L500 Φ50

- RM200** Φ100 L200 Φ55
- RM201** Φ100 L250 Φ55
- RM202** Φ100 L300 Φ55
- RM203** Φ100 L350 Φ55
- RM204** Φ100 L400 Φ55
- RM205** Φ100 L450 Φ55
- RM206** Φ100 L500 Φ55

- RM300** Φ100 L200 Φ60
- RM301** Φ100 L250 Φ60
- RM302** Φ100 L300 Φ60
- RM303** Φ100 L350 Φ60
- RM304** Φ100 L400 Φ60
- RM305** Φ100 L450 Φ60
- RM306** Φ100 L500 Φ60

- RM400** Φ100 L200 Φ64
- RM401** Φ100 L250 Φ64
- RM402** Φ100 L300 Φ64
- RM403** Φ100 L350 Φ64
- RM404** Φ100 L400 Φ64
- RM405** Φ100 L450 Φ64
- RM406** Φ100 L500 Φ64

- RM500** Φ100 L200 Φ70
- RM501** Φ100 L250 Φ70
- RM502** Φ100 L300 Φ70
- RM503** Φ100 L350 Φ70
- RM504** Φ100 L400 Φ70
- RM505** Φ100 L450 Φ70
- RM506** Φ100 L500 Φ70

- RM600** Φ100 L200 Φ76
- RM601** Φ100 L250 Φ76
- RM602** Φ100 L300 Φ76
- RM603** Φ100 L350 Φ76
- RM604** Φ100 L400 Φ76
- RM605** Φ100 L450 Φ76
- RM606** Φ100 L500 Φ76

ALUMINIZED RESONATOR MUFFLERS

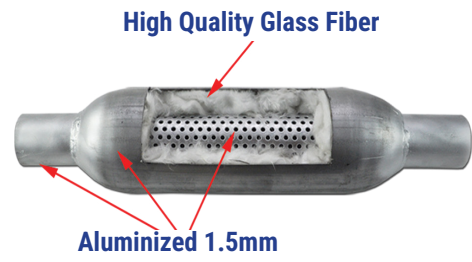
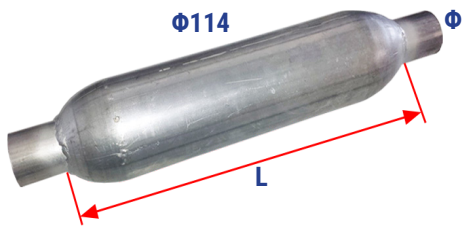

RM701 $\Phi 114$ L250 $\Phi 76$
RM702 $\Phi 114$ L300 $\Phi 76$
RM703 $\Phi 114$ L350 $\Phi 76$
RM704 $\Phi 114$ L400 $\Phi 76$
RM705 $\Phi 114$ L450 $\Phi 76$
RM706 $\Phi 114$ L500 $\Phi 76$

RM801 $\Phi 114$ L250 $\Phi 89$
RM802 $\Phi 114$ L300 $\Phi 89$
RM803 $\Phi 114$ L350 $\Phi 89$
RM804 $\Phi 114$ L400 $\Phi 89$
RM805 $\Phi 114$ L450 $\Phi 89$
RM806 $\Phi 114$ L500 $\Phi 89$

RM901 $\Phi 114$ L250 $\Phi 101$
RM902 $\Phi 114$ L300 $\Phi 101$
RM903 $\Phi 114$ L350 $\Phi 101$
RM904 $\Phi 114$ L400 $\Phi 101$
RM905 $\Phi 114$ L450 $\Phi 101$
RM906 $\Phi 114$ L500 $\Phi 101$

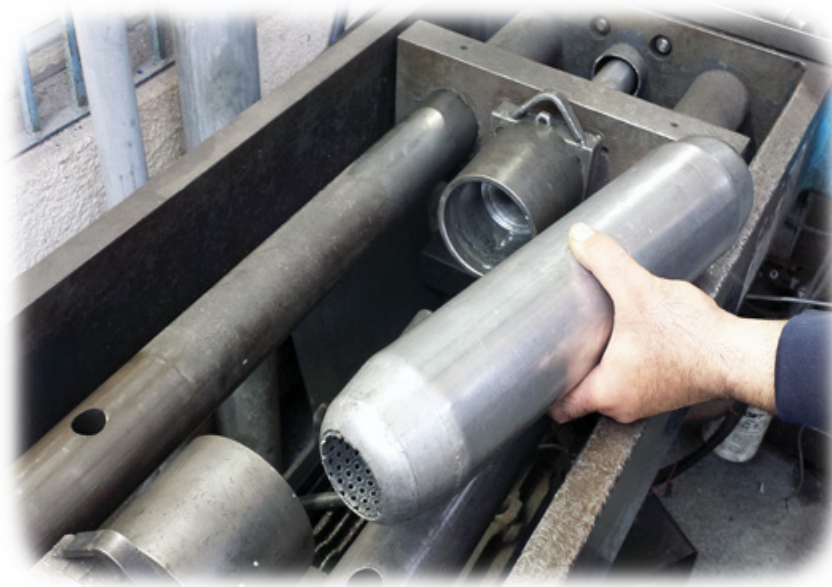

ALUMINIZED RESONATOR MUFFLERS

Low Sound Construction

Reduce the sound by 20%!!!

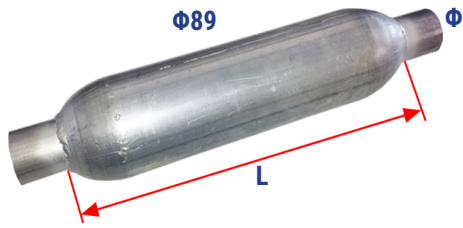

- RM20LS Φ89 L200 Φ38
- RM21LS Φ89 L250 Φ38
- RM22LS Φ89 L300 Φ38
- RM23LS Φ89 L350 Φ38
- RM24LS Φ89 L400 Φ38
- RM25LS Φ89 L450 Φ38
- RM26LS Φ89 L500 Φ38

- RM30LS Φ89 L200 Φ42
- RM31LS Φ89 L250 Φ42
- RM32LS Φ89 L300 Φ42
- RM33LS Φ89 L350 Φ42
- RM34LS Φ89 L400 Φ42
- RM35LS Φ89 L450 Φ42
- RM36LS Φ89 L500 Φ42

- RM40LS Φ89 L200 Φ45
- RM41LS Φ89 L250 Φ45
- RM42LS Φ89 L300 Φ45
- RM43LS Φ89 L350 Φ45
- RM44LS Φ89 L400 Φ45
- RM45LS Φ89 L450 Φ45
- RM46LS Φ89 L500 Φ45

- RM50LS Φ89 L200 Φ48
- RM51LS Φ89 L250 Φ48
- RM52LS Φ89 L300 Φ48
- RM53LS Φ89 L350 Φ48
- RM54LS Φ89 L400 Φ48
- RM55LS Φ89 L450 Φ48
- RM56LS Φ89 L500 Φ48

- RM60LS Φ89 L200 Φ50
- RM61LS Φ89 L250 Φ50
- RM62LS Φ89 L300 Φ50
- RM63LS Φ89 L350 Φ50
- RM64LS Φ89 L400 Φ50
- RM65LS Φ89 L450 Φ50
- RM66LS Φ89 L500 Φ50

- RM70LS Φ89 L200 Φ55
- RM71LS Φ89 L250 Φ55
- RM72LS Φ89 L300 Φ55
- RM73LS Φ89 L350 Φ55
- RM74LS Φ89 L400 Φ55
- RM75LS Φ89 L450 Φ55
- RM76LS Φ89 L500 Φ55

- RM80LS Φ89 L200 Φ60
- RM81LS Φ89 L250 Φ60
- RM82LS Φ89 L300 Φ60
- RM83LS Φ89 L350 Φ60
- RM84LS Φ89 L400 Φ60
- RM85LS Φ89 L450 Φ60
- RM86LS Φ89 L500 Φ60

Low Sound Construction

Reduce the sound by 20%!!!

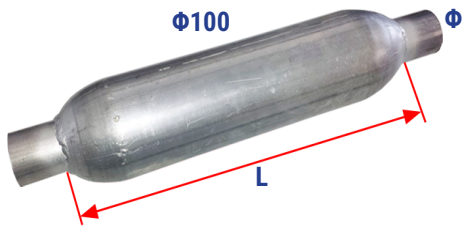

- RM100LS Φ100 L200 Φ50
- RM101LS Φ100 L250 Φ50
- RM102LS Φ100 L300 Φ50
- RM103LS Φ100 L350 Φ50
- RM104LS Φ100 L400 Φ50
- RM105LS Φ100 L450 Φ50
- RM106LS Φ100 L500 Φ50

- RM200LS Φ100 L200 Φ55
- RM201LS Φ100 L250 Φ55
- RM202LS Φ100 L300 Φ55
- RM203LS Φ100 L350 Φ55
- RM204LS Φ100 L400 Φ55
- RM205LS Φ100 L450 Φ55
- RM206LS Φ100 L500 Φ55

- RM300LS Φ100 L200 Φ60
- RM301LS Φ100 L250 Φ60
- RM302LS Φ100 L300 Φ60
- RM303LS Φ100 L350 Φ60
- RM304LS Φ100 L400 Φ60
- RM305LS Φ100 L450 Φ60
- RM306LS Φ100 L500 Φ60

- RM400LS Φ100 L200 Φ64
- RM401LS Φ100 L250 Φ64
- RM402LS Φ100 L300 Φ64
- RM403LS Φ100 L350 Φ64
- RM404LS Φ100 L400 Φ64
- RM405LS Φ100 L450 Φ64
- RM406LS Φ100 L500 Φ64

ALUMINIZED RESONATOR MUFFLERS

Low Sound Construction

Reduce the sound by 20%!!!

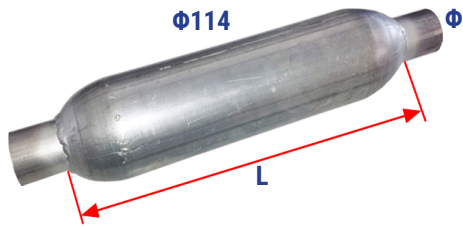

- RM701LS $\Phi 114$ L250 $\Phi 76$
- RM702LS $\Phi 114$ L300 $\Phi 76$
- RM703LS $\Phi 114$ L350 $\Phi 76$
- RM704LS $\Phi 114$ L400 $\Phi 76$
- RM705LS $\Phi 114$ L450 $\Phi 76$
- RM706LS $\Phi 114$ L500 $\Phi 76$

